

# IRFIZ24NPbF

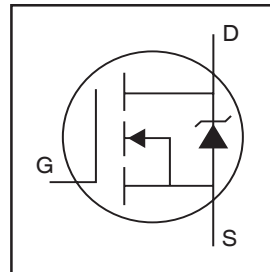
HEXFET® Power MOSFET

- Advanced Process Technology
- Isolated Package
- High Voltage Isolation = 2.5KVRMS ⑤
- Sink to Lead Creepage Dist. = 4.8mm
- Fully Avalanche Rated
- Lead-Free

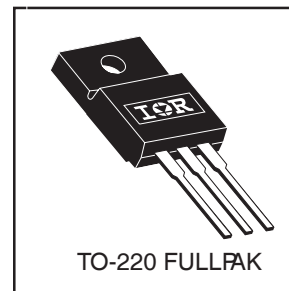
## Description

Fifth Generation HEXFETs from International Rectifier utilize advanced processing techniques to achieve extremely low on-resistance per silicon area. This benefit, combined with the fast switching speed and ruggedized device design that HEXFET Power MOSFETs are well known for, provides the designer with an extremely efficient and reliable device for use in a wide variety of applications.

The TO-220 Fullpak eliminates the need for additional insulating hardware in commercial-industrial applications. The moulding compound used provides a high isolation capability and a low thermal resistance between the tab and external heatsink. This isolation is equivalent to using a 100 micron mica barrier with standard TO-220 product. The Fullpak is mounted to a heatsink using a single clip or by a single screw fixing.



$V_{DSS} = 55V$
$R_{DS(on)} = 0.07\Omega$
$I_D = 14A$



## Absolute Maximum Ratings

	Parameter	Max.	Units
$I_D @ T_C = 25^\circ C$	Continuous Drain Current, $V_{GS} @ 10V$	14	A
$I_D @ T_C = 100^\circ C$	Continuous Drain Current, $V_{GS} @ 10V$	10	
$I_{DM}$	Pulsed Drain Current ①⑥	68	
$P_D @ T_C = 25^\circ C$	Power Dissipation	29	W
	Linear Derating Factor	0.19	W/°C
$V_{GS}$	Gate-to-Source Voltage	$\pm 20$	V
$E_{AS}$	Single Pulse Avalanche Energy②⑥	71	mJ
$I_{AR}$	Avalanche Current①⑥	10	A
$E_{AR}$	Repetitive Avalanche Energy①	2.9	mJ
dv/dt	Peak Diode Recovery dv/dt ③④	5.0	V/ns
$T_J$	Operating Junction and	-55 to + 175	°C
$T_{STG}$	Storage Temperature Range		
	Soldering Temperature, for 10 seconds		
	Mounting torque, 6-32 or M3 screw	10 lbf•in (1.1N•m)	

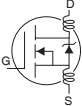
## Thermal Resistance

	Parameter	Typ.	Max.	Units
$R_{\theta JC}$	Junction-to-Case	—	5.2	°C/W
$R_{\theta JA}$	Junction-to-Ambient	—	65	

# IRFIZ24NPbF

International  
 Rectifier

## Electrical Characteristics @ $T_J = 25^\circ\text{C}$ (unless otherwise specified)

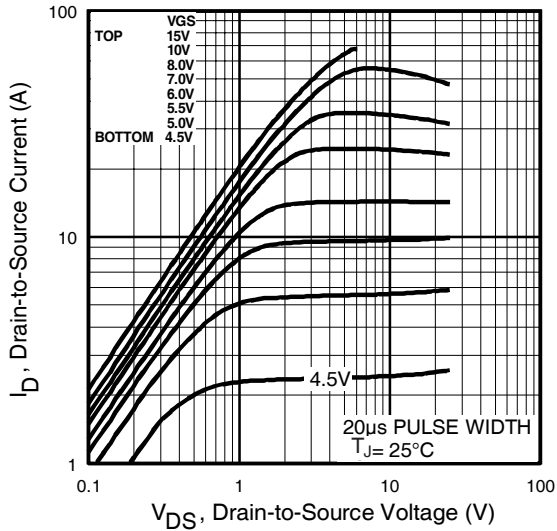
	Parameter	Min.	Typ.	Max.	Units	Conditions
$V_{(BR)DSS}$	Drain-to-Source Breakdown Voltage	55	—	—	V	$V_{GS} = 0V, I_D = 250\mu A$
$\Delta V_{(BR)DSS}/\Delta T_J$	Breakdown Voltage Temp. Coefficient	—	0.052	—	V/ $^\circ\text{C}$	Reference to $25^\circ\text{C}, I_D = 1\text{mA}$ ④
$R_{DS(on)}$	Static Drain-to-Source On-Resistance	—	—	0.07	$\Omega$	$V_{GS} = 10V, I_D = 7.8A$ ④
$V_{GS(th)}$	Gate Threshold Voltage	2.0	—	4.0	V	$V_{DS} = V_{GS}, I_D = 250\mu A$
$g_{fs}$	Forward Transconductance	4.5	—	—	S	$V_{DS} = 25V, I_D = 10A$ ⑥
$I_{DSS}$	Drain-to-Source Leakage Current	—	—	25	$\mu A$	$V_{DS} = 55V, V_{GS} = 0V$
		—	—	250		$V_{DS} = 44V, V_{GS} = 0V, T_J = 150^\circ\text{C}$
$I_{GSS}$	Gate-to-Source Forward Leakage	—	—	100	nA	$V_{GS} = 20V$
	Gate-to-Source Reverse Leakage	—	—	-100		$V_{GS} = -20V$
$Q_g$	Total Gate Charge	—	—	20	nC	$I_D = 10A$
$Q_{gs}$	Gate-to-Source Charge	—	—	5.3		$V_{DS} = 44V$
$Q_{gd}$	Gate-to-Drain ("Miller") Charge	—	—	7.6		$V_{GS} = 10V$ , See Fig. 6 and 13 ④ ⑥
$t_{d(on)}$	Turn-On Delay Time	—	4.9	—	ns	$V_{DD} = 28V$
$t_r$	Rise Time	—	34	—		$I_D = 10A$
$t_{d(off)}$	Turn-Off Delay Time	—	19	—		$R_G = 24\Omega$
$t_f$	Fall Time	—	27	—		$R_D = 2.6\Omega$ , See Fig. 10 ④ ⑥
$L_D$	Internal Drain Inductance	—	4.5	—	nH	Between lead, 6mm (0.25in.) from package and center of die contact
$L_S$	Internal Source Inductance	—	7.5	—		
$C_{iss}$	Input Capacitance	—	370	—	pF	$V_{GS} = 0V$
$C_{oss}$	Output Capacitance	—	140	—		$V_{DS} = 25V$
$C_{rss}$	Reverse Transfer Capacitance	—	65	—		$f = 1.0\text{MHz}$ , See Fig. 5 ⑥
C	Drain to Sink Capacitance	—	12	—		$f = 1.0\text{MHz}$

## Source-Drain Ratings and Characteristics

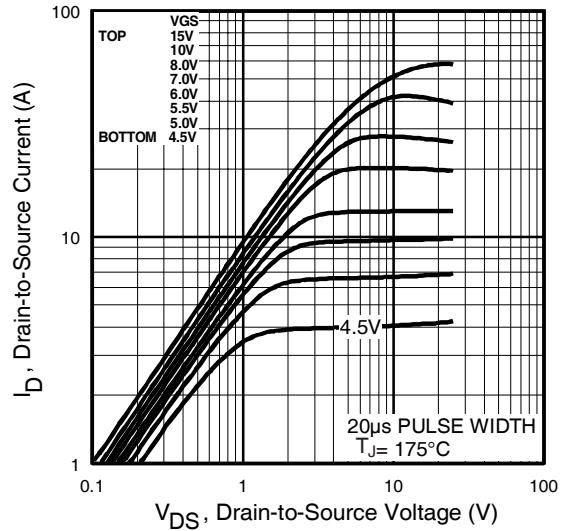
	Parameter	Min.	Typ.	Max.	Units	Conditions
$I_S$	Continuous Source Current (Body Diode)	—	—	14	A	MOSFET symbol showing the integral reverse p-n junction diode.
$I_{SM}$	Pulsed Source Current (Body Diode) ① ⑥	—	—	68		
$V_{SD}$	Diode Forward Voltage	—	—	1.3	V	$T_J = 25^\circ\text{C}, I_S = 7.8A, V_{GS} = 0V$ ④
$t_{rr}$	Reverse Recovery Time	—	56	83	ns	$T_J = 25^\circ\text{C}, I_F = 10A$
$Q_{rr}$	Reverse Recovery Charge	—	120	180	$\mu C$	$di/dt = 100A/\mu s$ ④ ⑥
$t_{on}$	Forward Turn-On Time	Intrinsic turn-on time is negligible (turn-on is dominated by $L_S+L_D$ )				

### Notes:

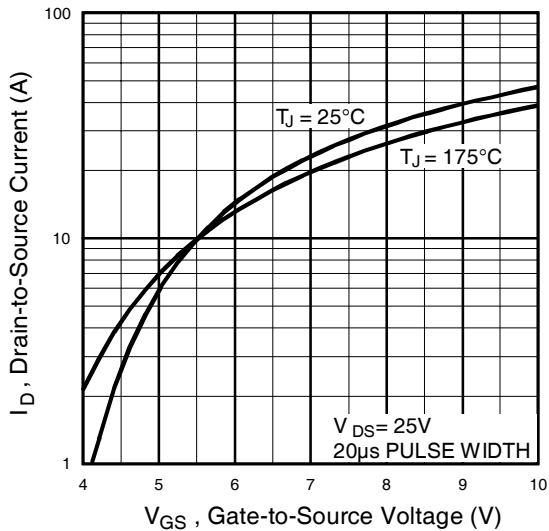
- ① Repetitive rating; pulse width limited by max. junction temperature. ( See fig. 11 )
- ②  $V_{DD} = 25V$ , starting  $T_J = 25^\circ\text{C}$ ,  $L = 1.0\text{mH}$   
 $R_G = 25\Omega, I_{AS} = 10A$ . (See Figure 12)
- ③  $I_{SD} \leq 10A, di/dt \leq 280A/\mu s, V_{DD} \leq V_{(BR)DSS}, T_J \leq 175^\circ\text{C}$
- ④ Pulse width  $\leq 300\mu s$ ; duty cycle  $\leq 2\%$ .
- ⑤  $t = 60s, f = 60\text{Hz}$
- ⑥ Uses IRFZ24N data and test conditions



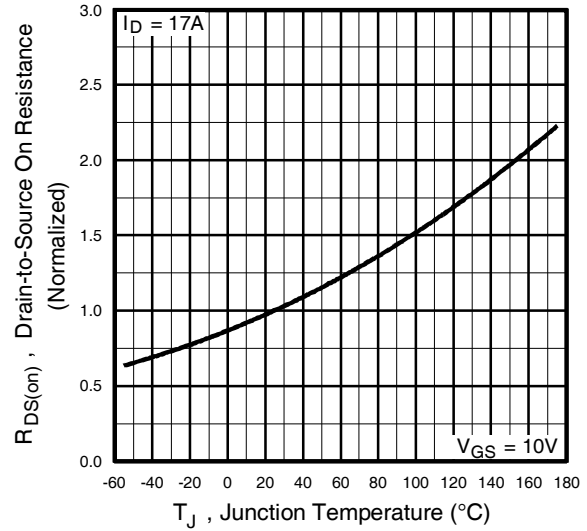
**Fig 1.** Typical Output Characteristics



**Fig 2.** Typical Output Characteristics



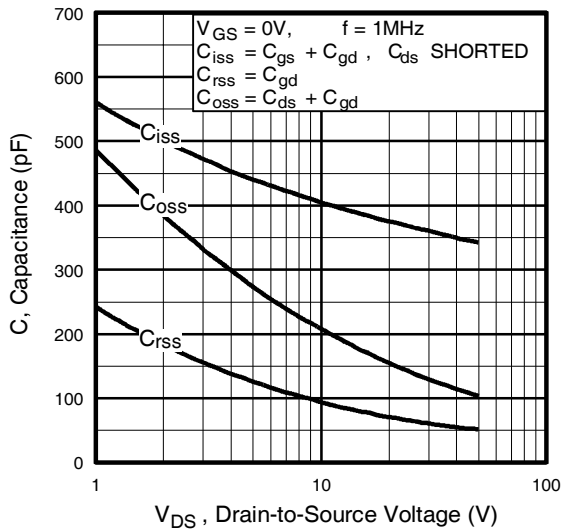
**Fig 3.** Typical Transfer Characteristics



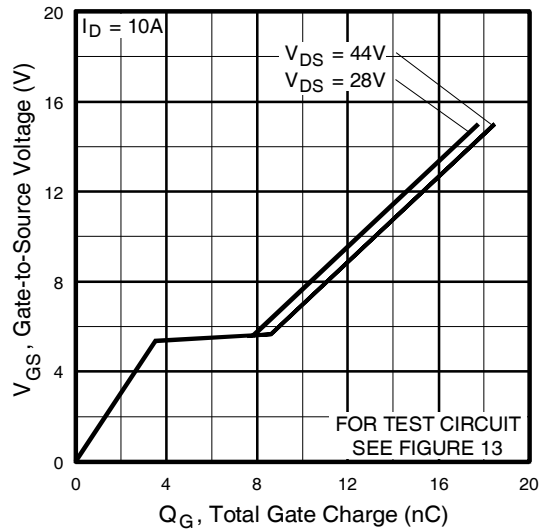
**Fig 4.** Normalized On-Resistance Vs. Temperature

# IRFIZ24NPbF

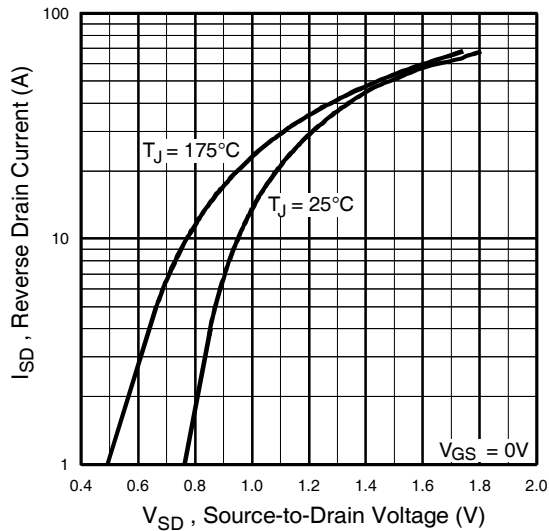
International  
**IR** Rectifier



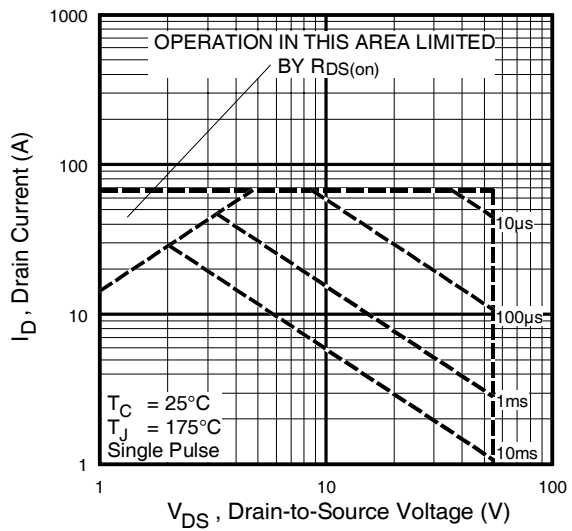
**Fig 5.** Typical Capacitance Vs. Drain-to-Source Voltage



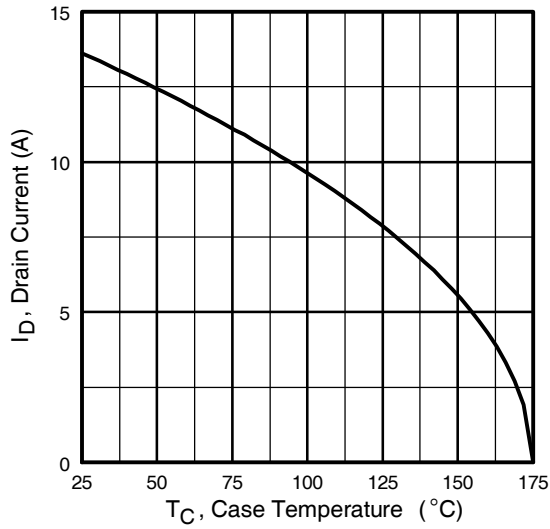
**Fig 6.** Typical Gate Charge Vs. Gate-to-Source Voltage



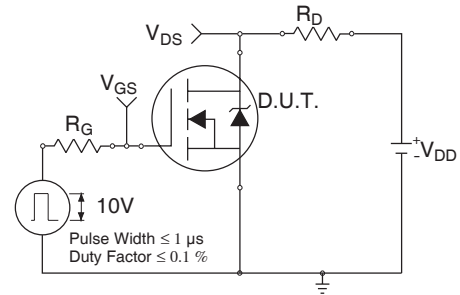
**Fig 7.** Typical Source-Drain Diode Forward Voltage



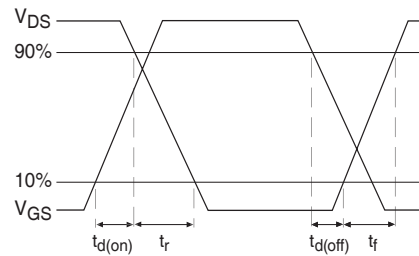
**Fig 8.** Maximum Safe Operating Area



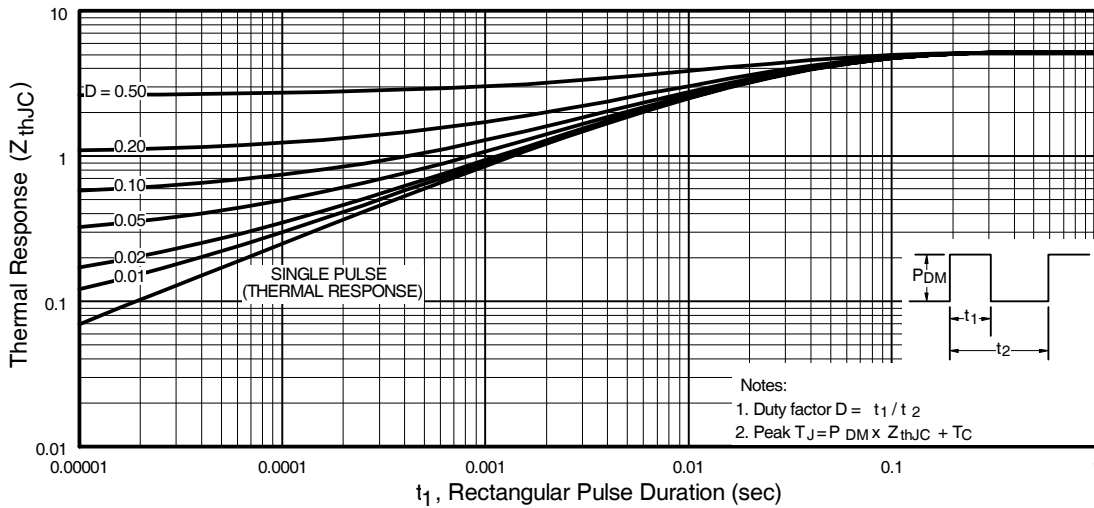
**Fig 9.** Maximum Drain Current Vs. Case Temperature



**Fig 10a.** Switching Time Test Circuit



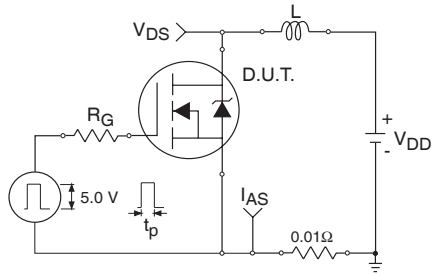
**Fig 10b.** Switching Time Waveforms



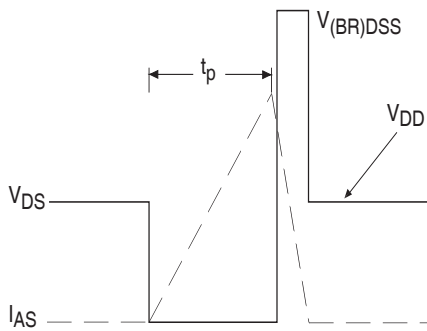
**Fig 11.** Maximum Effective Transient Thermal Impedance, Junction-to-Case

# IRFIZ24NPbF

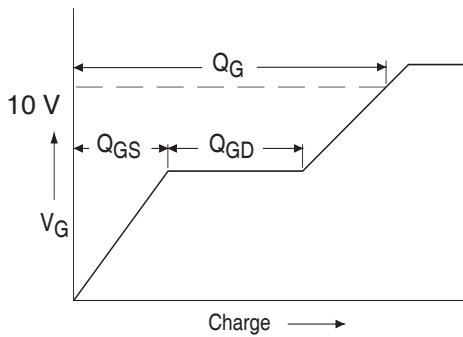
International  
**IR** Rectifier



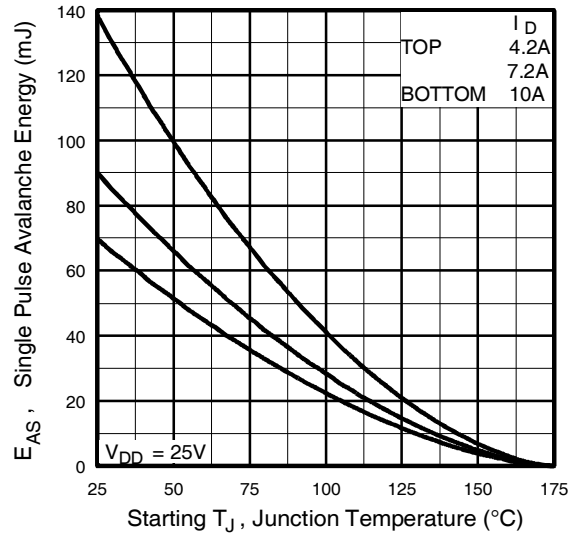
**Fig 12a.** Unclamped Inductive Test Circuit



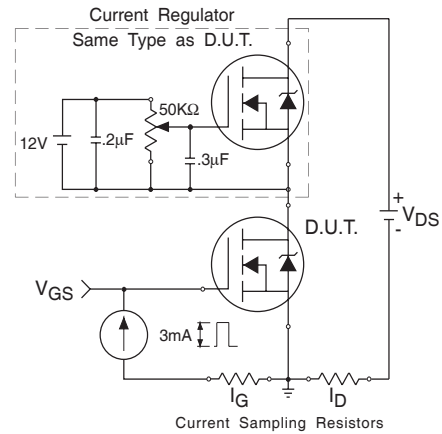
**Fig 12b.** Unclamped Inductive Waveforms



**Fig 13a.** Basic Gate Charge Waveform

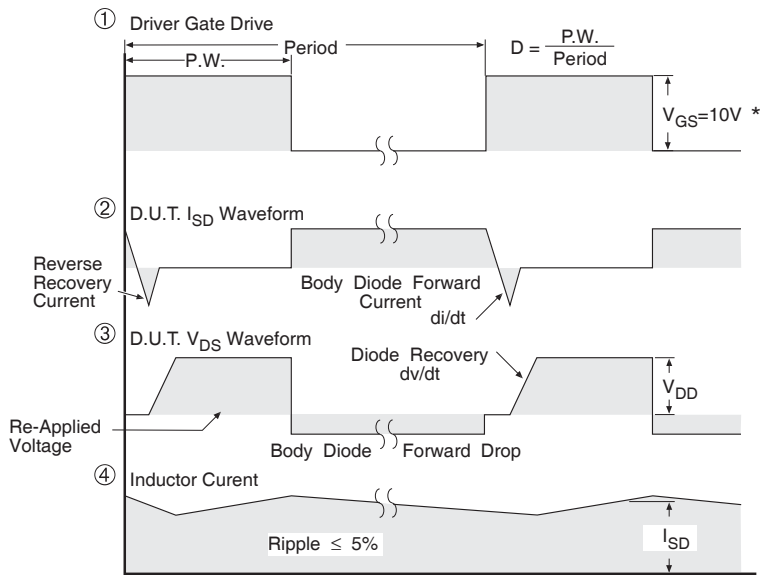
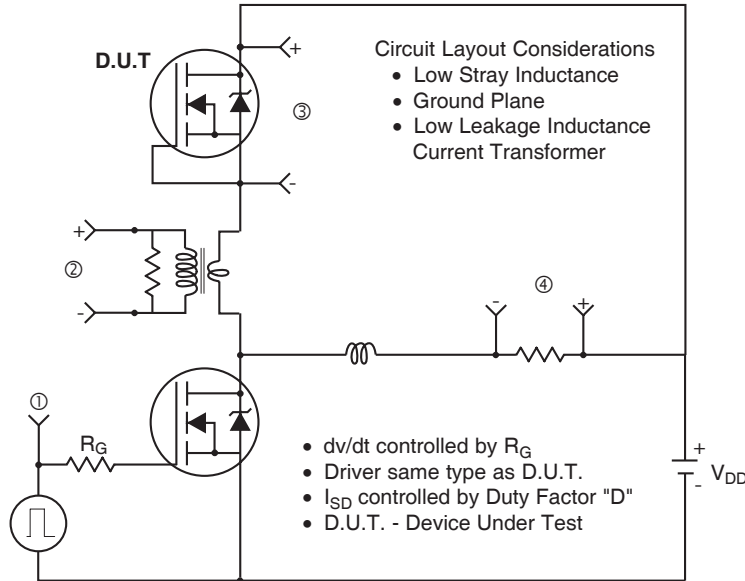


**Fig 12c.** Maximum Avalanche Energy Vs. Drain Current



**Fig 13b.** Gate Charge Test Circuit

## Peak Diode Recovery dv/dt Test Circuit



\*  $V_{GS} = 5V$  for Logic Level Devices

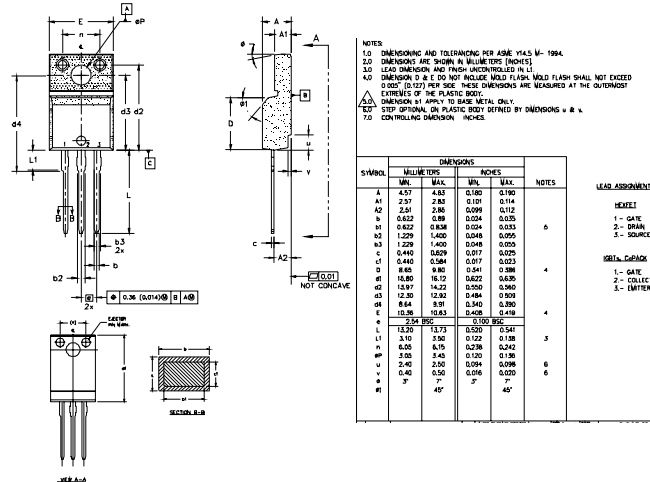
**Fig 14. For N-Channel HEXFETS**

# IRFIZ24NPbF

International  
**IOR** Rectifier

## TO-220 Full-Pak Package Outline

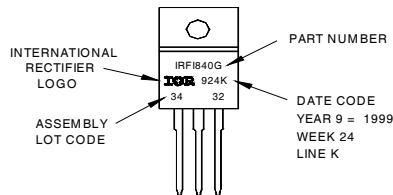
Dimensions are shown in millimeters (inches)



## TO-220 Full-Pak Part Marking Information

EXAMPLE: THIS IS AN IRF1840G  
WITH ASSEMBLY  
LOT CODE 3432  
ASSEMBLED ON WW 24 1999  
IN THE ASSEMBLY LINE "K"

Note: "P" in assembly line position indicates "Lead-Free"



Data and specifications subject to change without notice.

International  
**IOR** Rectifier

IR WORLD HEADQUARTERS: 233 Kansas St., El Segundo, California 90245, USA Tel: (310) 252-7105  
TAC Fax: (310) 252-7903

Visit us at [www.irf.com](http://www.irf.com) for sales contact information.11/03



Note: For the most current drawings please refer to the IR website at:  
<http://www.irf.com/package/>